



**Dräger's Guide to
Portable Gas Detection**
(according to EN Regulations)

D-23492-2012



Gases – what is Gaseous Matter?

STL-1097-2008

Matter with a temperature above its boiling point is said to be a gas. With respect to a human environment (normal conditions), any substance with a boiling point below 20°C at normal pressure is a gas. The lightest gas is hydrogen (H_2 , fourteen times lighter than air); the heaviest gas (about ten times heavier than air) is tungsten hexafluoride (WF_6).

Under normal conditions, 1 cm³ of gas contains about 30 trillion molecules. The average distance between each of these molecules is only about three nanometers. They swarm through space at some 100 to 1000 meters per second and collide some billion times per second with other molecules, so that between two collisions they can only fly about 50 to 100 nanometers. With each collision, they change their flight direction and transfer energy to their collision partner.

This is an entirely random movement of molecules, which is macroscopically measurable such as temperature (average kinetic energy of all molecules), pressure (average momentum of all molecules striking a surface) or extension (volume). Pressure, temperature and volume are in a fixed relationship based on external conditions. Ideally, they follow the so-called ideal gas laws, i.e. at constant pressure, a gas volume changes proportional to its temperature – e.g. it expands when heated

- **at constant pressure the gas volume changes proportional to its temperature** – e.g. the volume will be increased when heated
- **at constant volume (such as in a closed vessel) the pressure changes proportional to the temperature** – e.g. the inner pressure of the vessel increases when heated
- **at constant temperature, pressure changes inversely proportion to volume** – e.g. the internal pressure increases when the gas is compressed

The extremely quick, random movement of gas molecules is also the reason that gases mix easily and never segregate from each other. The movement of molecules toward lower concentrations (diffusion) is also based on these molecular characteristics and plays an important role in the measuring principles of gas sensors. In general, these diffusion processes are quicker, the faster the molecules move (the hotter the gas) and the lower the molar weight (the lighter the gas).

Vapors – aren't they Gases too?

STL-1098-2008

Unlike gases – of which there may be only 200 to 300 – the term vapor is used for the gaseous state of matter below its boiling point. Vapor always exists in equilibrium with its liquid (sometimes also solid) phase – it condenses and evaporates depending on the temperature. This behavior is best recognized in water: The cooling of humid air at nighttime causes fog (condensation) – but the warmth of the morning sun dissolves the fog again (evaporation).

In a closed vessel, the maximum vapor concentration always occurs above the surface of a liquid. This concentration is dependent on the temperature of the liquid. From a microscopic point of view, vapor is generated by the random movement of the liquid's molecules and their ability to overcome the surface tension and mix with the air molecules above.

Each liquid has a certain characteristic vapor pressure that solely depends on the liquid's temperature. This pressure is equal to the atmospheric pressure when the liquid reaches its boiling point. The graph of this correlation is known as the vapor pressure curve, which enables the determination of the maximum possible vapor concentration at any given temperature.

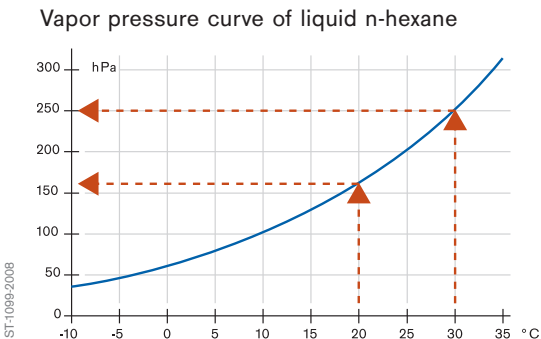

Dividing the maximum possible vapor pressure by the ambient pressure results in the saturation concentration, which is measured in Vol.-%. For n-hexane at 20°C (vapor pressure 162 mbar) at an ambient pressure of 1000 mbar, the maximum possible n-hexane concentration is 16.2 Vol.-%.

Vapors – aren't they Gases too?

Our Atmosphere

While continuously decreasing its specific weight, our atmosphere extends far into deep space. The sky's blue color is caused by scattering sunlight on air molecules (mainly nitrogen and oxygen). The sky is actually already black at a height of about 21 km. If the atmosphere was maintained at a constant pressure of 1013 mbar, its height would be 8 km and the UV-absorbing stratospheric ozone layer would only be 3 mm thick.

Typical composition of the earth's atmosphere in ppm:

Gas	Composition	
	Dry	Humid
Main gases		
N ₂ – Nitrogen	780 840	768 543
O ₂ – Oxygen	209 450	206 152
H ₂ O – Water vapor	0	15 748
Ar – Argon	9 340	9 193
CO ₂ – Carbon dioxide	340	335
Trace gases		
Ne – Neon	18	18
He – Helium	5	5
CH ₄ – Methane	1.8	1.8
Kr – Krypton	1.1	1.1
H ₂ – Hydrogen	0.5	0.5
N ₂ O – Nitrous oxide	0.3	0.3
CO – Carbon monoxide	0.09	0.09
Xe – Xenon	0.09	0.09
O ₃ – Ozone	0.07	0.07
Additional trace gases	3.05	3.0
Total	1000 000	1000 000

1 Vol.-% = 10 000 ppm; assumed for moist air: 68% r.h. at 20 °C

The earth's atmosphere has a mass of about five quadrillion tons ($5.235 \cdot 10^{18}$ kg), pressing down on the earth's surface of $0.507 \cdot 10^{15}$ m². This is why we have an atmospheric pressure of 10,325 kg/m², which corresponds to our standard pressure of 1,013 mbar.

Atmospheric pressure decreases as altitude increases:

Altitude	Atmospheric pressure
-1000 m	1148 mbar
- 500 m	1078 mbar
0 m	1013 mbar
500 m	952 mbar
1000 m	900 mbar
1500 m	840 mbar

Height	Atmospheric pressure
2000 m	795 mbar
3000 m	701 mbar
4000 m	616 mbar
5000 m	540 mbar
6000 m	472 mbar
8000 m	356 mbar

Since fewer molecules are present in a given volume at a lower atmospheric pressure, the result of partial pressure measuring gas detectors is always dependent on the atmospheric pressure.

While nitrogen, as the main gas in our atmosphere at more than 78 Vol.-%, is completely inert and, despite its excess, cannot be used by plants as a much needed fertilizer in this gaseous state, oxygen is very reactive and forms the basis of our breathing and existence, moreover: the basis of nearly every living being.

There is nearly 21 Vol.-% oxygen in our atmosphere. Oxygen deficiency is life-threatening and cannot be detected by our sense of smell.

As a general rule, **oxygen deficiency** is caused by the release of inert gases, which then in turn displace oxygen. Since roughly one-fifth of the atmosphere is oxygen, the oxygen concentration is only reduced by one-fifth of the concentration of inert gas. For example, if 10 Vol.-% of helium is released into the atmosphere, the oxygen concentration decreases by 2 Vol.-%, while the nitrogen concentration is reduced by 8 Vol.-%. Because liquid nitrogen (-196 °C) is often used in industrial areas, a dangerous oxygen deficiency can quickly arise due to the evaporation of this liquid nitrogen.

Enhanced oxygen concentrations (e.g. more than 25 Vol.-%) cannot be sensed by humans, but have severe consequences

with respect to the flammability of materials, and may even cause auto-ignition. This is the why explosion protection measures are only related to the atmospheric oxygen concentration.

When does it become dangerous?

Oxygen concentration in Vol.-%	Oxygen partial pressure in mbar	Symptoms
Below 17	Below 170	Dangerous tendencies due to oxygen deficiency
11 to 14	110 to 140	Unnoticeable decrease in physical and mental capabilities
8 to 11	80 to 110	Possible sudden loss of consciousness without warning after a certain period of exposure
6 to 8	60 to 80	Loss of consciousness within a few minutes, resuscitation possible if performed instantly
Below 6	Below 60	Immediate loss of consciousness



ST-11289-2008

Gases and vapors are almost always dangerous! If gases do not exist in their familiar and breathable atmospheric compositions, safe breathing is already at risk. Furthermore: All gases are potentially dangerous. Whether in liquefied, compressed or normal state – it is their concentration that is crucial.

There are basically three categories of risk:

- **Risk of explosion (Ex)** by flammable gases
- **Oxygen (Ox)**
 - Risk of asphyxiation due to oxygen displacement
 - Risk of increased flammability due to oxygen enrichment
- **Risk of poisoning (Tox)** by toxic gases

Without auxiliary tools, humans are not able to recognize these dangers early enough to initiate appropriate countermeasures. With few exceptions, our nose has turned out to be an extremely unreliable warning instrument.

For example, low concentrations of hydrogen sulfide can be sensed through the typical odor of rotten eggs, but our nose cannot detect the lethal high concentrations. Escaping into areas assumed to be safe due to the lack of smell has already caused many fatal accidents.

Even harmless gases such as argon, helium or nitrogen may become dangerous when a sudden release of these gases displaces vitally important oxygen. Here, there is a risk of suffocation. Oxygen concentrations of less than 6 Vol.-% are known to be lethal. Excess oxygen increases the risk of flammability and may even cause auto-ignition of flammable materials. If ignited, flammable gases and vapors not only cause considerable damage to assets and property, but they can also compromise human life.

It is essential to detect Ex, Ox, and Tox risks reliably and to take appropriate measures to protect human lives, assets and the environment.

Whether Dräger-Tubes or portable gas detectors – Dräger offers you individual solutions to tackle gas risks professionally.

Toxic Gases and Vapors

The toxicity of gases and vapors used in industrial processes is determined using laboratory experiments that calculate the LC₅₀ rate. Based on these investigations and additional scientific and occupational health investigations, authorized commissions in several countries make their recommendations for limit values, which are then legally binding. In Germany, this is the Federal Institute for Occupational Safety and Health (BauA).

These limit values are defined to prevent employees from being harmed, provided they do not breathe in a higher gas concentration than the stated threshold limit value throughout their entire working lives. This, however, must be ensured.

Limit value*	Selected substances that correspond to this limit value
5000 ppm	Carbon dioxide
1000 ppm	Propane, Butane
500 ppm	Acetone
200 ppm	Methyl ethyl ketone (MEK)
100 ppm	Butanol
50 ppm	n-Hexane, Toluene

20 ppm	Acetonitrile
10 ppm	Chlorobenzene
5 ppm	Diethylamine
1 ppm	1.1.2.2-Tetrachloroethane
500 ppb	Chlorine
200 ppb	Methyl chloroformate
100 ppb	Chlorine dioxide
50 ppb	Glutaraldehyde
10 ppb	Methyl isocyanate

* 10 ppb Methylisocyanate

Status 2010, according to TRGS 900 (Germany)

T+ very toxic LC₅₀ < 0,5 g/m³

Arsine, Boron trichloride, Boron trifluoride, Bromine, Diborane, Fluorine, Hydrogen cyanide, Hydrogen fluoride, Hydrogen phosphide, Hydrogen sulfide, Nitrogen dioxide, Nitrogen monoxide, Ozone, Phosgene, Sulfur tetrafluoride, Tungsten hexafluoride

T toxic LC₅₀ = 0,5 ... 2,0 g/m³

Acetonitrile, Ammonia, Benzene, Carbon disulfide, Carbon monoxide, Chlorine, Cyanogen, Hydrogen chloride, Methanol, Methyl bromide, Nitrogen trifluoride, Sulfur dioxide

LC₅₀ (LC stands for lethal concentration) reflects the gas concentration in air that will kill 50% of laboratory animals (primarily white lab rats) when inhaled for a certain period of time (typically four hours).

Flammable Gases and Vapors

Flammable gases become more dangerous when they have a relatively low explosion limit (LEL). Flammable vapors become more dangerous when they have a relatively low flash point. The flash point is defined by the liquid's temperature-dependent vapor pressure and its LEL.

Vapor	LEL Vol.-%	LEL g/m ³	Flash Point in °C	Vapor Pressure at 20°C in mbar	Ignition Temperature in °C
Acetone	2.5	60.5	< -20	246	535
Acrylonitrile	2.8	61.9	-5	117	480
Benzene	1.2	39.1	-11	100	555
n-Butanol	1.7	52.5	35	7	325
n-Butyl acetate	1.2	58.1	27	11	390
n-Butyl acrylate	1.2	64.1	37	5	275
Chlorobenzene	1.3	61.0	28	12	590
Cyclohexane	1.0	35.1	-18	104	260
Cyclopentane	1.4	40.9	-51	346	320
1,2-Dichloroethane (EDC)	6.2	255.7	13	87	440
Diethyl ether	1.7	52.5	-40	586	175
1,4-Dioxane	1.9	69.7	11	38	375
Epichlorohydrin	2.3	88.6	28	16	385
Ethanol	3.1	59.5	12	58	400
Ethyl acetate	2.0	73.4	-4	98	470
Ethyl benzene	1.0	44.3	23	10	430
n-Hexane	1.0	35.9	-22	160	240
Methanol	6.0	80.0	9	129	440
1-Methoxy-2-propanol	1.8	67.6	32	12	270
Methyl ethyl ketone (MEK)	1.5	45.1	-10	105	475
Methyl methacrylate	1.7	70.9	10	40	430
n-Nonane	0.7	37.4	31	5	205
n-Octane	0.8	38.1	12	14	205
n-Pentane	1.4	42.1	-40	562	260
i-Propanol (IPA)	2.0	50.1	12	43	425
Propylene oxide	1.9	46.0	-37	588	430
Styrol	1.0	43.4	32	7	490
Tetrahydrofuran (THF)	1.5	45.1	-20	200	230
Toluene	1.1	42.2	6	29	535
Xylene (isomeric mixture)	1.0	44.3	25	7	465

Gas	LEL Vol.-%	LEL g/m ³	Ignition Temperature in °C
Acetylene	2.3	24.9	305
Ammonia	15.4	109.1	630
1,3-Butadiene	1.4	31.6	415
i-Butane	1.5	36.3	460
n-Butane	1.4	33.9	365
n-Butene (Butylene)	1.2	28.1	360
Dimethyl ether	2.7	51.9	240
Ethene (Ethylene)	2.4	28.1	440
Ethylene oxide	2.6	47.8	435
Methane	4.4	29.3	595
Methyl chloride	7.6	159.9	625
Propane	1.7	31.2	470
Propene (Propylene)	1.8	31.6	485
Hydrogen	4.0	3.3	560

Only flammable liquids have a flash point

By definition, there are no flash points for flammable gases.

LEL and Preventive Explosion Protection

Flammable gases and vapors can form flammable mixtures when combined with air, but only if the proportion of flammable gas and oxygen (or air) is within certain limits.

The lower explosion limit (LEL) is defined as the concentration of combustion gas (given in Vol.-%) in a combustion gas-air mixture which, under standard conditions, can be ignited and will continue to burn. The LEL of all known flammable gases and vapors is in the range of approximately 0.5 to 15 Vol.-%. For example, the LEL of hydrogen-air mixtures is 4 Vol.-%, and thus a test gas with 2 Vol.-% hydrogen in air can definitely not be ignited.

Concentration limitation

This behavior is very important for practical explosion protection: If a flammable gas cannot be ignited below its LEL concentration,

explosion protection can be performed by continuously measuring the gas concentration and taking appropriate measures to ensure that, for example, half of the LEL (= 50% LEL) is never exceeded.

This method of preventive explosion protection is often known as the primary measure: it reliably prevents the forming, but not the ignition, of a potentially explosive atmosphere. For this purpose, concentration measurement is preferably performed using infrared or catalytic bead sensors, which must comply with standardized safety requirements.

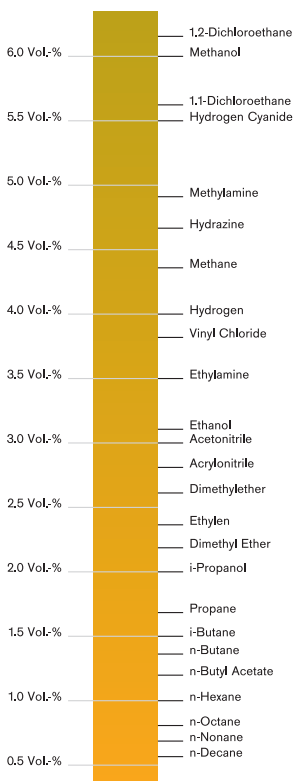
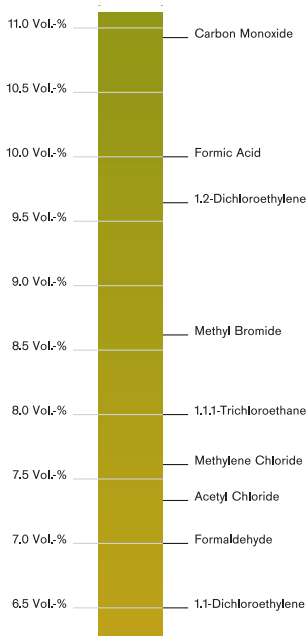

Flash Point of Flammable Liquids

ST-3101-2004

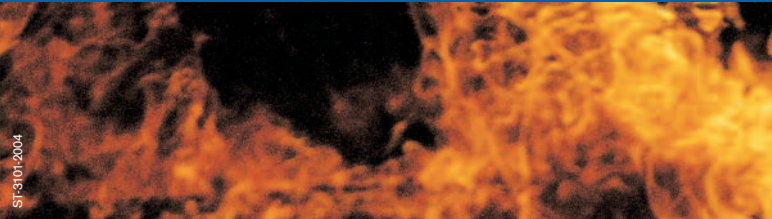

Although we speak of flammable liquids, it is not the liquid, but the vapor that is flammable. Only vapor can form a flammable mixture with atmospheric oxygen. Both the volatility of the vapor and its lower explosion limit (LEL) are measures for the risk of explosion. These are described by the flash point.

To even be ignitable, the concentration of the liquid's vapor above the liquid's surface must exceed the LEL. The amount of vapor generated determines whether or not it ignites. The vapor pressure, which is dependent on the liquid's temperature, is responsible for this. With respect to the safety of flammable goods, this behavior is described by the flash point (F): The flash point is the temperature at which enough vapor is produced for the vapor-air mixture to be ignited by a standardized apparatus. For example, if the flash point of a flammable liquid is above 50°C, this liquid definitely cannot be ignited at 30°C.

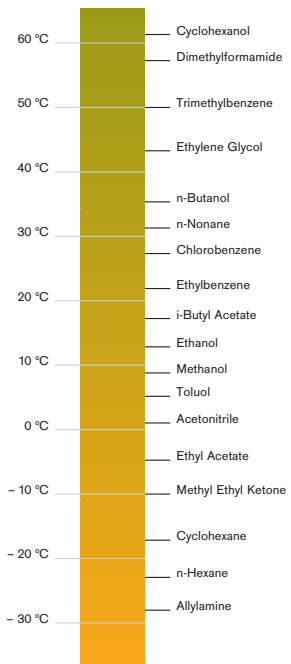

You cannot ignite diesel (F > 55°C) with a burning match, but you can ignite gasoline (F < -20°C)!

In conclusion, the lower the flash point of a flammable liquid is, the more dangerous it can be. Since vapors of flammable liquids cannot be ignited below their flash point, preventive explosion protection can also be implemented by using liquids with a flash point significantly higher than the ambient temperature.

Although this is the common practice, when liquids are used as solvents there is a disadvantage: less volatile liquids require more energy for evaporation.

By definition, gases do not have a flash point because they have no liquid phase under normal conditions.

Flash Point of Flammable Liquids

Concentrations And Their Calculation

Concentrations are specified as the percentage of a substance in a reference substance. In regards to the measurement of hazardous substances in the air, a concentration is used to define the quantity of the substance in reference to air. A corresponding dimension is used in order to gain simple, manageable figures for the specification of a concentration. High concentrations are generally specified in percent by volume (Vol.-%). This corresponds to a defined amount of the substance in 100 parts air, for example air consists of 21 Vol.-% oxygen (100 parts air contain 21 parts oxygen).

For small concentrations, the measurement units parts per million (ppm or mL/m³) or parts per billion (ppb or μL/m³) is used.

The concentration specification ppm means 1 part substance in 1 million parts air (in comparison: 1 sugar cube in a tanker). The concentration specification ppb means 1 part substance in 1 billion parts air (in comparison: 5 people in the entire population of the earth). The calculation for this very small concentration in Vol.-% results in this simple relationship:

$$1 \text{ Vol.-%} = 10\,000 \text{ ppm} = 10\,000\,000 \text{ ppb}$$

In addition to gaseous components, air can also contain "dissolved" solid or liquid substances also known as aerosols. Because these air-transported drops or particles are smaller, a volume specification is not used. The concentration of aerosols is specified in mg/m³.

		Vol.-%	ppm	ppb
Vol.-% =	10 L/m ³ 1 cL/L	1	10 ⁴	10 ⁷
ppm =	mL/m ³ μL/L	10 ⁻⁴	1	10 ³
ppb =	μL/m ³ nL/L	10 ⁻⁷	10 ⁻³	1

Because each volume is connected to the respective mass, the so-called volume concentrations of gaseous substances can be converted into mass concentrations and vice versa. However, these calculations must be specified for a certain temperature and a certain pressure, as the gas density is dependent on these two environmental aspects. For measurements at workplaces, 20°C and 1,013 hPa are usually specified as the reference parameters. The calculation takes place using simple formulas.

		g/L	mg/L	mg/m ³
g/L =	10 L/m ³ 1 cL/L	1	10 ³	10 ⁶
mg/L =	mL/m ³ μL/L	10 ⁻³	1	10 ³
mg/m ³	μL/m ³ nL/L	10 ⁻⁶	10 ⁻³	1

Calculation mg/m³ – ppm

$$c_{[\text{ppm}]} = \frac{\text{Molar volume}}{\text{Molar mass}} \cdot c$$

$$c_{[\text{mg/m}^3]} = \frac{\text{Molar mass}}{\text{Molar volume}} \cdot c$$

The molar volume of a gas is 24.1 L/mol at 20°C and 1,013 hPa. The molar mass of a specific gas should be adapted dependent on that gas.



Today, gas detector tubes are one of the classic measurement methods for gas analysis. This versatile system can be used within numerous applications in industrial fields, the fire service and hazardous material control in laboratories, for environmental research and many other areas.

Dräger-Tubes can be schematically classified utilizing the following criteria:

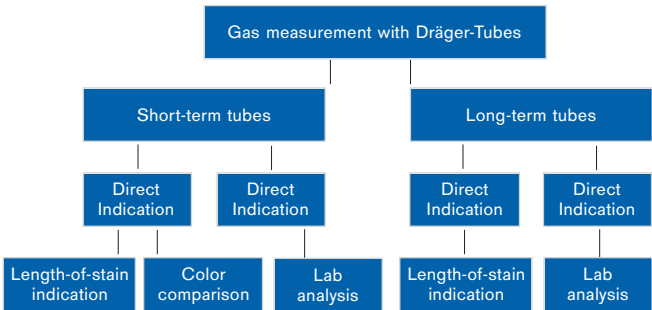

The Dräger-Tube measurement system consists of a Dräger-Tube and a Dräger pump. Each Dräger-Tube contains a very sensitive reagent system that produces accurate readings when the technical characteristic of the gas detector pump precisely match the reaction kinetics of the reagent system in the tube. Therefore, a pump, delivering the correct volume must also pull the sample through the Dräger-Tube at the proper rate. These requirements are referenced in both international and national detector tube standards or norms, which require or recommend that detector tubes be used with a matching pump from the same manufacturer.

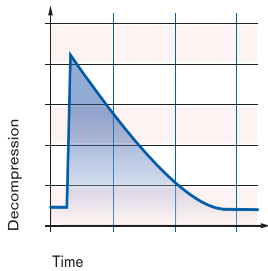

D-16393-2009

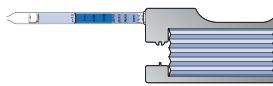

Dräger accuro®

D-27831-2009

Direct Indicating Dräger-Tubes

Direct-indicating short-term tubes provide precise measurement results directly after measurement. Time-consuming trips to the laboratory are therefore unnecessary. Also, the tubes do not require an additional calibration by the user. He receives the calibration in the form of a scale on the tube. At present, more than 220 short-term tubes are available for the detection of up to 500 gases.

The principle is startlingly simple:

A test system, which reacts by changing color when it comes into contact with a certain gas or vapor, is located on a solid carrier material within an enclosed gas tube – the Dräger-Tube. A defined quantity of ambient air is suctioned through the tube using, for example, the Dräger accuro pump. Even the smallest quantities of gas are sufficient to trigger a reaction. The scale on the tube allows the user to evaluate the concentration of the hazardous substance directly after the measurement. For applications in which single or less regular measurements are sufficient, Dräger Tubes are particularly advantageous compared to electronic detection devices, as they are cheaper and easier to operate. The number of gases/vapors that can be detected is also far higher than other detection instruments with direct display.

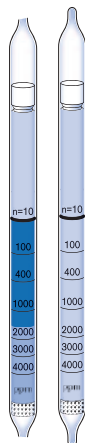

D-16498-2009

Long-term tubes with direct indication

In contrast to short-term tubes, no pump is necessary for sampling with these measurement devices. The contaminant molecules automatically move into the tube according to Fick's First Law of Diffusion. The driving force for this movement of the contaminant molecules is the concentration differential between the ambient air and the inside of the tube. Since the diffusion tubes do not require a pump and go unnoticed when wearing, they are particularly effective as personal monitors. Normally the measurements are performed between 0.5 and eight hours. Long-term measurements with diffusion tubes provide integrated measurements that represent the average concentration during the sampling period.

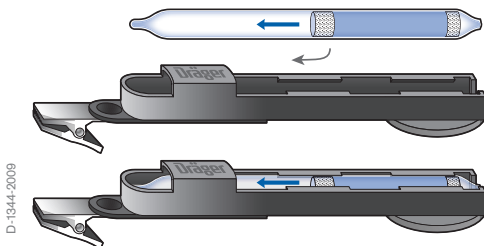

D-1344-2009

Diffusion tube with direct indication in holder

Further information: Dräger-Tubes / CMS Handbook and the hazardous substance database, VOICE (www.draeger.com)

Dräger Sampling Tubes & Systems

ST-1166-2004

For the measurement of trace concentrations (e.g. in an office or outside) or complex mixtures of substances (e.g. in workplaces), a selective measurement with sampling systems and the subsequent laboratory analysis is suitable. The complete analysis can be forwarded to official positions or archived for documentation purposes.

A differentiation is made between active and passive sample collection:

Active sample collection:

For active sampling, the air to be evaluated is drawn through a sampling tube with a pump (e.g. Dräger accuro pump). The substance to be collected accumulates on the adsorbent (e.g. charcoal). The concentration is calculated from the mass of the hazardous material, which is determined during the analysis, and the volume of the sample air.

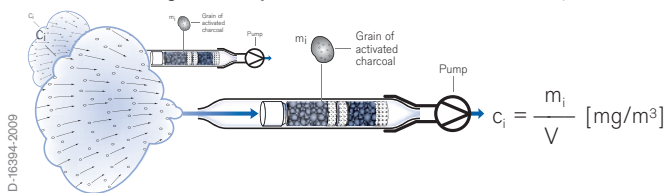

Passive sampling

In the case of sample collection using a diffusion sampler, the contaminant molecules from the ambient air follow a defined diffusion course and are immediately absorbed by the sorbent when they reach the sorption layer. The mass of the adsorbed hazardous substance is calculated in accordance with the first Fick law of diffusion. Further details: Dräger-Tubes & CMS- Handbook and the hazardous substance database, VOICE.

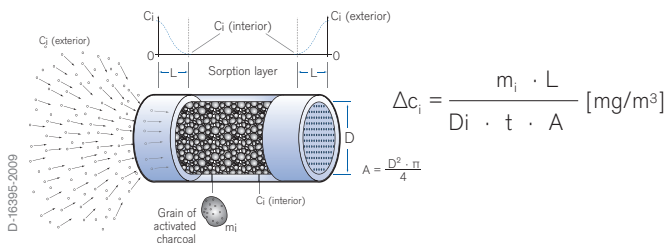

Dräger-Tube	Sample collection type	Substance or group of substances, which can be collected
Activated charcoal tubes	Active	Aliphatic, aromatic hydrocarbons, solvent vapors, ester, ketone, alcohols, glycol ether, fluorinated hydrocarbons
ORSA diffusion sampler	Passive	Aliphatic, aromatic hydrocarbons, solvent vapors, ester, ketone, alcohols, glycol ether, fluorinated hydrocarbons
Silica gel tubes	Active	Strong ionic, organic connections, such as alcohols, phenols, cresols
Amines sampling tube	Active	Aliphatic amine and dialkyl sulfate
Aldehyde sampling set	Active	Aldehyde, such as formaldehyde, acetaldehyde, acrolein, glutaraldehyde
Isocyanate sampling set	Active	Isocyanate, such as HDI, 2.4 TDI, MDI
Nitrous oxide diffusion sampler	Passive	Nitrous oxide



The Dräger Analytical Services specializes in air examinations in all areas, in which hazardous substances may be present.

These include:

- Workplaces, in which hazardous substances are dealt with;
- Offices and other interior spaces (e.g. nurseries, apartments, assembly rooms, truck cabins, etc.), in which the air may be contaminated by vapors from building materials or furnishings;
- Exhaust air from businesses and industrial plants
- Compressed air, soil gas in contaminated earth
- Gas emissions from material samples

Independent sample collection

Dräger offers suitable systems for inexpensive and independent sample collection, consisting of Dräger pumps, collection media, sample collection records and dispatch bags for the Analytical Services. The collection systems used by the customer are closed once the samples have been collected, and are sent to the Dräger Analytical Services in Lübeck along with a sample collection record.

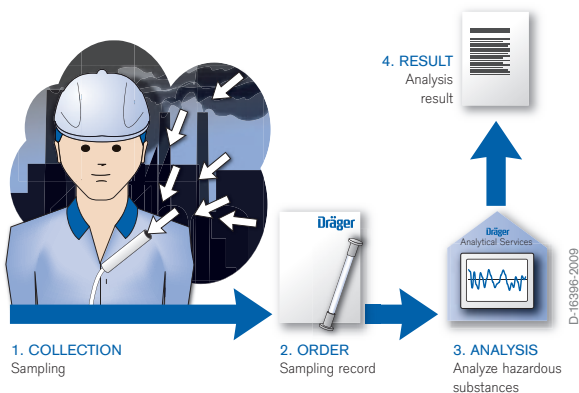

Air investigations at the workplace by sampling on site followed by laboratory analysis

Dräger Measurement Center

The Dräger Measurement Center, which is accredited in accordance with DIN EN ISO/IEC 17025, offers a complete range of services for the management of hazardous substances. The services provided include consulting, measurement planning, execution of sample collection and measurements on-site, analysis of samples, as well as the evaluation of results in the form of a measurement report or survey.

Dräger CMS-Chip

The Dräger Chip-Measurement-System is a new generation of chemical gas detection technology. Dräger CMS is a system for quantitative determination of hazardous gas or vapor concentrations in the air. The measurement is carried out in the workplace to monitor for hazardous gas concentrations, process control, and for measurements in confined spaces, etc. This system is designed for short-term measurement.

The complete measurement system consists of two main components:

- Substance-specific chips
- Analyzer

The chip

Each chip contains ten measurement capillaries filled with a substance-specific reagent system. Compared with other measurement systems, chemical reagent systems have distinct advantages. One reason for this is, that it is possible to supplement the reacting layer with one or more pre-layers to adsorb moisture, to trap interfering substances, or to convert substances into measurable substances.

This ensures that the measurement result is substance-specific.

The reactive preparations necessary for detection are kept in hermetically-sealed glass capillaries until needed. The chip housing also protects the capillaries from possible external, mechanical or chemical influences.

When the chip is inserted into the analyzer all information required for the measurement is transferred to the analyzer by means of a bar code:

- the substance to be measured
- the measurement range
- the measurement time
- the parameters for the calibration function
- the required flow rate

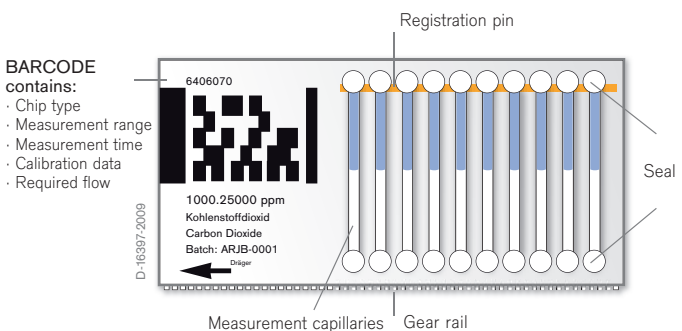

The Chip

Further information: Dräger-Tubes / CMS Handbook and the hazardous substance database, VOICE (www.draeger.com)

Dräger CMS-Analyzer

ST-B40-2004

The analyzer records the measurement effect optoelectronically, thereby eliminating human factors. The gas inlet for the sample air is located at the front of the analyzer and is protected from dust and other impurities.

When the integrated mechanics have established an air-tight connection between the entire gas conduction system and the open capillary of the chip, a special pump system pulls a constant mass-flow of air through the capillary. The pump system consists of a mass-flow controller, a processor and a small electric membrane pump. The processor regulates the pump for the necessary mass-flow. This combination supports an accurate mass-flow and compensates for fluctuations in the ambient air pressure, within certain limits. No correction of the measurement result is necessary, regardless of whether the measurement is taken at the Dead Sea or in the mountain air of Mexico City.

Schematic display of CMS measurement principle:

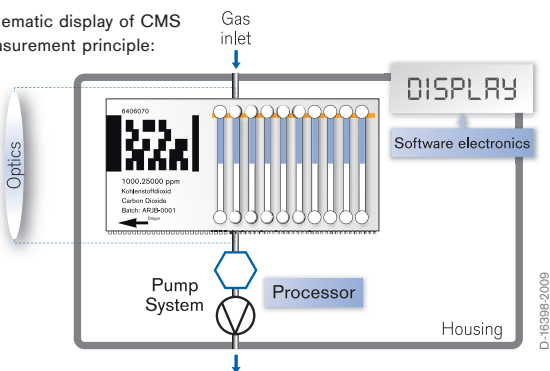

The measurement principle of the CMS is based on a dynamic dose measurement which is dependent on concentration. The basis for this principle is chemical kinetics, whereby the speed of the chemical reaction in the capillary depends on the concentration of the sample. For the chip measurement system, this means defined and short measurement times. The measurement time is not constant, but is directly related to the concentration, i.e. the higher the concentration, the shorter the measurement time. The corresponding position of the optical unit allows a direct determination of the speed of the chemical reaction within the capillary. Since concentration and reaction speed are directly proportional, the analyzer terminates the measurement very quickly when high concentrations are present.

Electrochemical Sensors



Many toxic gases are very reactive and can change their chemical composition under certain conditions. An electrochemical sensor is a micro-reactor, which produces a small but measurable amount of current when reactive gases are present. As is the case with a normal household battery, electrochemistry is involved because the chemical reaction produces electrons.

An electrochemical sensor consists of at least two electrodes (the measuring electrode and the counter electrode). These electrodes have contact with each other in two different ways: on the one hand via an electrically conductive medium called electrolyte (a liquid to transport ions), on the other hand via an external electric circuit (electronic conductor). The electrodes are made of a special material that also has catalytic characteristics, enabling certain chemical reactions to take place in the so-called 3-phase zone, where gas, solid catalyst and liquid electrolyte are present. However, a dual-electrode sensor (measuring electrode and counter electrode) has many disadvantages. For example, should higher concentrations of gases be present, this can lead to higher currents in the sensor and a voltage drop. The voltage drop then changes the preconfigured sensor voltage. This, in turn, can lead to the production of unusable measurement signals or, in the worst case, a chemical reaction in the sensor that goes unnoticed during measurement.

For this reason, the Dräger XS and XXS Sensors contain a third electrode, the so-called reference electrode, which has no electrical current and whose electric potential, therefore, remains constant. This is used to continuously measure the sensor voltage at the measurement electrode, which can be corrected by the sensor's internal control enhancement. This significantly improves measurement quality (e.g. with regard to linearity behavior and selectivity) and leads to a longer life time.

Further information: Instrument & Sensor Handbook and the hazardous substance database, VOICE (www.draeger.com)

Electrochemical sensor

- CO-Molecule**
Target gas, enters into the measuring electrode
- CO₂-Molecule**
Reaction product, leaves the measuring electrode
- H₂O-Molecule**
part of the electrolyte
- H⁺ Hydrogen-Ion**
positive charge (because one electron is missing)
- Oxygen atom**
- Oxygen-Molecule**
from the ambient air
- Electron**

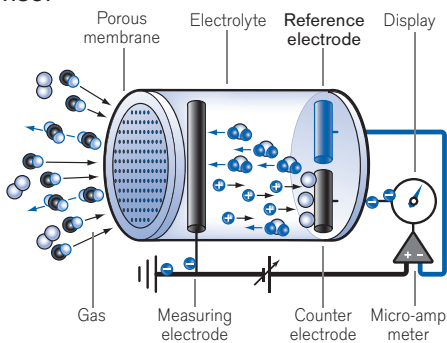

Chemical reaction at the measuring electrode



Chemical reaction at the counter electrode



Catalytic Bead Sensors

Under certain circumstances, flammable gases and vapors can be oxidized with the oxygen within the ambient air and release reaction heat. Typically, this is achieved through the use of special and suitably heated catalyst material, which slightly increases its temperature through the resulting heat of reaction. This slight increase in temperature is a measure for the gas concentration.

Within a porous ceramic bead (diameter under 1 mm), there is a small platinum wire coil embedded. An electric current flows through

Catalytic bead sensors

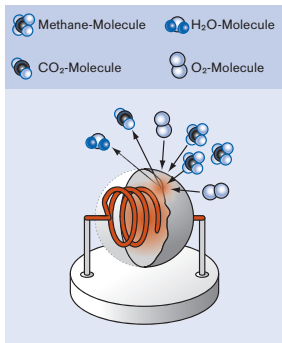

Reaction

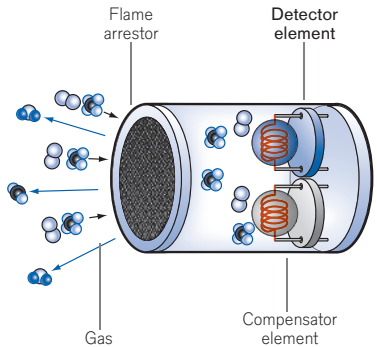

the platinum wire coil so that the pellistor is heated up to some hundred degrees Celsius. If the pellistor contains the suitable catalytic material, its temperature will continue to rise in the presence of flammable gases, and the platinum wire coil's resistance will increase accordingly. This change in resistance can now be evaluated electronically.

To eliminate any changes in the ambient temperature, a second pellistor is used, which is very similar but does not respond to gas (e.g. because the pellistor does not contain the necessary catalyst material). Integrating both the pellistors in a Wheatstone bridge circuit results in a sensor for detecting flammable gases and vapors in the air, which to a large extent is independent of the ambient temperature. Because the catalytic bead sensor contains hot pellistors, it can (if the lower exposure level – LEL – is exceeded) act as an ignition source. This is prevented by using a metal sinter disk. If an ignition takes place in the interior of the catalytic bead sensor, the sensor's housing withstands the explosion pressure and the flame is cooled down to below the ignition temperature of the gas. This ensures that the flame can not leave the sensor housing.

Futher information: Instrument & Sensor Handbook and the hazardous substance database, VOICE (www.draeger.com)

Infrared Sensors

All gases absorb radiation in a characteristic manner, some even in a visible range, for example 0.4 to 0.8 micrometers. This is why chlorine is green-yellow, bromine and nitrogen dioxide are brown-red, iodine is violet, and so on. However, these colors can only be seen at high and lethal concentrations.

Hydrocarbons, on the other hand, absorb radiation in a certain wavelength range, approx. 3.3 to 3.5 micrometers. Since the main components of air – oxygen, nitrogen and argon – do not absorb radiation in this range, this method can be used for measurement purposes. In a closed container containing gaseous hydrocarbons (e.g. methane or propane), the intensity of an incoming infrared light will be weakened. This weakening is dependent on the concentration of the gas.

IR sensor

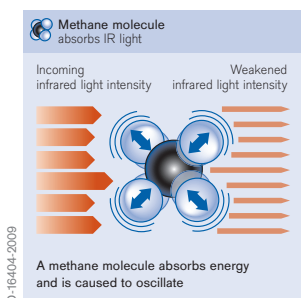

Reaction

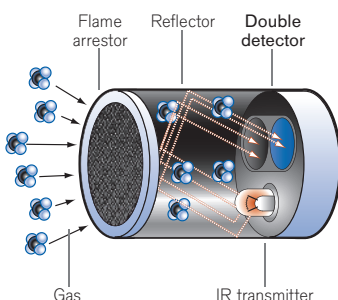

Air: Infrared light passes through without weakening – Intensity remains the same

Gas (e.g. methane): Infrared light weakens when passing – reduced intensity corresponds to the concentration of methane.

This is the principle behind an infrared measuring instrument, as used with Dräger Infrared sensors. Most flammable gases and vapors are hydrocarbons, which almost always can be detectable because of their characteristic behavior in regards to infrared absorption.

Functional principle: The ambient air to be measured is guided to the measuring cell by diffusion or through the use of a pump. From the infrared transmitter, wide-band radiation finds its way into the cell through a window. It is then reflected onto the mirrored walls, passing through a window onto the double detector. The double detector consists of a measurement and reference detector. If the gas mixture contains hydrocarbons, then a part of the radiation is adsorbed and the measurement detector produces a small electrical signal. The reference detector's signal remains unchanged. Fluctuations in the performance of the infrared transmitter, contamination of the mirrors and windows, as well as disruptions in the ambient air caused by dust or aerosols affect both detectors to the same degree, and, therefore, are fully compensated.

Further information: Instrument & Sensor Handbook and the hazardous substance database, VOICE (www.draeger.com)

PID Sensors

Many flammable gases and vapors are toxic to humans long before they reach their lower explosion limit (LEL). For this reason, an additional measurement of volatile organic substances in the ppm range through the use of a PID sensor is an ideal supplement to the usual personal monitoring.

The air is drawn in through the gas inlet and into the measurement chamber. There, a UV lamp generates photons, which ionize certain molecules within the gas flow.

PID sensor

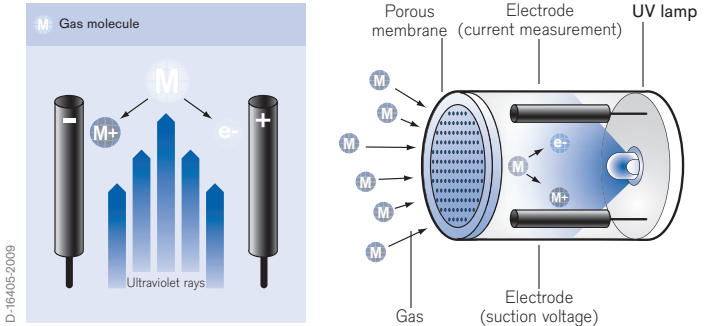

In order to ionize permanent gases in the air (such as inert gases, nitrogen, oxygen, carbon dioxide, and water vapor), a relatively high

amount of energy is required. For this reason, these gases do not disrupt the measurement of hazardous substances. Most organic substances which can be regarded as hazardous substances (e.g. hydrocarbons) are ionized and exposed to the electric field between the two electrodes in the measurement chamber. The strength of the resulting current is directly proportional to the concentration of ionized molecules in the detection chamber. This makes it possible to determine the concentration of the hazardous substance in the air.

Ionization energy and UV lamps

Ionization energy is measured in electron volts (eV) and specifies how much energy is required to ionize or charge one molecule. This ionization energy is substance-specific data, such as the boiling point or pressure. In order to ionize a certain substance, the ionization energy of that substance must be smaller than the photon energy of the lamp used with the photo ionisation detector (PID). Two different types of lamp are commonly used: the 10.6 eV lamp and the 11.7 eV lamp.

A PID is suitable for detecting entire groups of hazardous substances. However, when calibrated accordingly, it can also be used to detect an individual substance.

Further information: Instrument & Sensor Handbook and the hazardous substance database, VOICE (www.draeger.com)

Selecting the correct measurement principle is crucial to identifying gas-related risks. Each measurement principle has its strengths and limitations, and is optimized for certain groups of gases (flammable/toxic gases and oxygen).

For this reason, one important question is which gases/vapors occur at the workplace. It is generally possible to distinguish between the following gas-related risks:

Risk of explosion

- Wherever flammable gases or vapors exist, there is always an increased risk of explosion. This is typically the case in the following areas: mining, refining, chemical industries, and many more. Infrared and catalytic bead sensors are used here. These sensors typically record the gas concentration in a lower exposure level (LEL) range, but can also sometimes be used for the 100 Vol.-% range.

Oxygen displacement / oxygen excess

- Oxygen displacement is life-threatening. Oxygen excess affects the flammability of materials, up to the point where they can selfignite. Electrochemical sensors are usually used for measuring oxygen. The measurement range lies between 0 – 25 Vol.-% and up to 100 Vol.-%. Dräger-Tubes and CMS can also be used here.

Toxic gases

- Toxic substances can occur anywhere. In industrial manufacturing and treatment processes, during transport (rail, road or ship), during incomplete combustion, and also during completely natural processes such as decomposition and decaying processes of waste materials.

Various different measurement principles can be used to detect toxic gases.

- Dräger-Tubes
- CMS
- Electrochemical sensors
- PID sensors

How to identify the right principle for a certain application depends on several factors, such as:

- What other hazardous substances are present (cross sensitivities)
- Is it necessary to selectively measure hazardous substances, or does it make more sense to measure a total parameter
- Is short-term, long-term, or continuous measurement to be used
- Is it necessary to have warning and alarm functions when limits are exceeded

Portable gas detection instruments are subject to very diverse requirements. Different application areas require solutions tailored to the measurement task, which also take into account the respective application conditions.

It is generally possible to distinguish between the following application areas:

Personal monitoring

- The instruments should warn the wearer of gas-related risks in his/her immediate work area. They are usually worn directly on the work clothing. The basic requirements for these types of devices are, therefore, a high degree of comfort, robustness and reliability. Continuous detection devices for single gases or multiple gases are suitable for this measurement task. For short-term measurements (or spot measurements), Dräger-Tubes and CMS can also be used.

Area monitoring

- The task here is to monitor an area, in which one or more workers are active. The device is located in a central position, so that it can optimally monitor the work area. Robustness, stability and well-recognized alarms (visual and audible) are the basic requirements here. Continuous measurement devices for multiple gases should be used.

Confined Space Entry

- In order to perform maintenance or repair work, it is often necessary to enter confined spaces. Limited space, a lack of ventilation and the presence or development of hazardous substances result in particularly high risks in these work areas. A clearance measurement is required before entry. Multiple-gas detectors with corresponding pumps and accessories, such as hoses and probes, are recommended. After a successful measurement where no hazards have been found, the same devices can then be used for continuous personal monitoring while working within the confined spaces. Dräger-Tubes and CMS are also suitable for spot measurements.

Leak detection

- Leakages can occur anywhere where gases or liquids are stored or transported. It is important to identify these quickly in order to take appropriate measures to prevent damage to people, the environment and the facility. Detection instruments with corresponding pumps must have rapid response times in order to detect even slight changes in concentration. Extreme reliability is a minimum requirement for these instruments.

Single-Gas Instruments

If the risk caused by toxic gases or vapors can be narrowed down to a single gas or one conductive component, single gas detectors and warning instruments are the ideal solution for personal monitoring at the workplace. They are small, robust and ergonomic. The devices are typically worn directly on the worker's clothing, close to the breathing area, without restricting the workers' freedom of movement. The instruments continuously monitor the ambient air and issue an alarm (visual, audible and by vibration) when the gas concentration exceeds a limit preconfigured on the device. This allows workers to react directly to risks should incidents occur during standard operations, or if unforeseeable events occur during maintenance and repair work.



Dräger Pac® 3500 – 7000

The Pac 3500 – 7000 family is equipped with XXS sensors, which are miniature electrochemical sensors. They allow for a smaller, ergonomic instrument design. The sensor sits directly behind a replaceable dust and water filter, which protects it against environmental influences with negligible effects on the response times. Besides accuracy and reliability, the response time is crucial. The so-called t_{90} to t_{20} times provide information on how fast the sensor reacts to changes in the concentration of a gas. Due to the fast reaction time and very short diffusion paths, these sensors react extremely quickly and display any gas-related risk immediately. The sensor's electrical signal with the help of electronics and software is displayed as a concentration. Alarm thresholds are defined in the device (A1 = prewarning / A2 = main alarm). If these alarm thresholds are exceeded by the current gas concentration, then the device emits a visual, audible and vibrating alarm. Robustness and protection against explosive materials are two further important factors when selecting the correct gas detection instrument.

Dräger X-am 5100

The Dräger X-am 5100 is designed for the measurement of the gases / vapors hydrazine, hydrogen peroxide, hydrogen chloride and hydrogen fluoride. These special gas hazards are difficult to detect because they adsorb to different surfaces. The open gas inlet projecting from the device prevents that adsorbing surfaces are between the gas and the gas sensor. A rapid response of the proven XS sensors is thus also ensured for these special gases.

Multi-Gas Instruments

ST-7070-2005



If different hazardous substances (Ex-Ox-Tox) occur in the work place, it is advisable to use continuous measurement devices for multiple gases. They make it possible to use different measurement principles (infrared, catalytic bead, PID and electrochemical sensors) in one device, thus taking advantage of the respective strengths of each measurement principle.

The constellation of the sensors depends on the application in question. Up to 6 gases can be detected in real-time and continuously. Besides being used for personal or area monitoring, optional accessories also allow multi-gas instruments to be used for clearance measurements and leak detection.

Multi-gas instruments include Dräger X-am 1700, X-am 2000, X-am 3000, X-am 5000, X-am 5600 and X-am 7000.

Gas measurement technology (example: Dräger X-am[®] 7000)

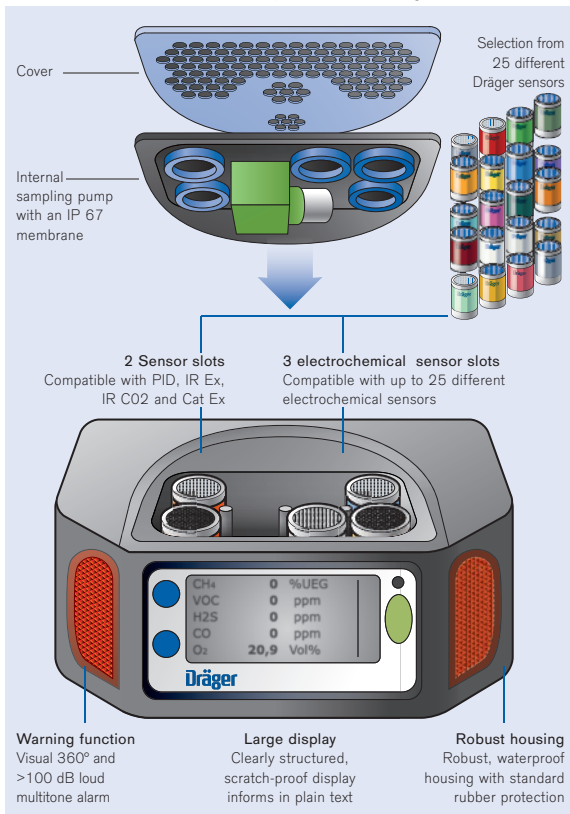

D-16407-2009

Multi-Gas Instruments

Explosion Protection

Industrial processes very frequently involve flammable substances and sometimes also flammable particles. In these areas, flammable gases and vapors may be released on a process-related basis (e.g. by relief valves) but also by unpredictable incidents. For prevention purposes, these hazardous areas are declared as Ex-areas (or “zones”), in which only equipment that is equipped with a suitable type of explosion protection and certified accordingly may be used.

Explosion protection is regulated worldwide. The basis for these standards, according to IEC (international), CENELEC (Europe) and NEC 505 (North America) is very similar and is based on the “3-zone concept”, which is also increasingly accepted in the USA.

Zone, according to IEC, NEC 505 and EN	Dangerous, explosive atmosphere is present...
Zone 0	continuously, regularly, or long-term
Zone 1	occasionally
Zone 2	rarely and short-term

The typical American method of explosion protection, in accordance with NEC 500, is based on the “2-divisions concept”:

Division, according to NEC 500	Dangerous, explosive atmosphere is present...
Division 1	continuously or occasionally
Division 2	rarely and short-term

According to IEC, NEC 505 and EN there are seven standardized types of protection for electrical equipment in zone 1, while in North America (USA/Canada) there are only three types of explosion protection for division 1 according to NEC 500:

Type of protection, according to IEC, NEC 505 and EN	Comparable type of protection, according to NEC 500
Explosion/Flame proof	Explosion proof
Encapsulation	–
Powder/Sand filling	–
Oil immersion	–
Artificial ventilation	Purged / pressurized
Increased safety	–
Intrinsic safety	Intrinsically safe

The standardized marking of a gas detection device, e.g. Ex de IIC T4, informs the user about the applicability in a designated hazardous area.

ATEX 95 – European Directive 94/9/EG

Also known as ATEX 95 (formerly ATEX 100a), mandatory in the European Union (EU) since July 1, 2003. Equipment and protective systems for use in potentially explosive atmospheres need to fulfill the Essential Health and Safety Requirements (EHSR) which are assumed to be met when based on certain harmonized standards.



Notified body concerning production and quality
EU-requirements are met

Marking (according to ATEX):



I M 2 / II 2 G

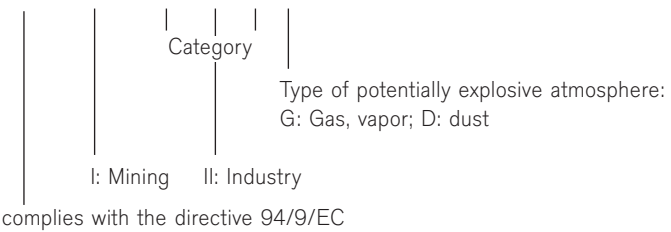

Explosion protection:

Ex d ia IIC T4 Gb

EPL (Equipment Protection Level) G = gas
D = dust; a = Zone 0; b = Zone 1; c = Zone 2

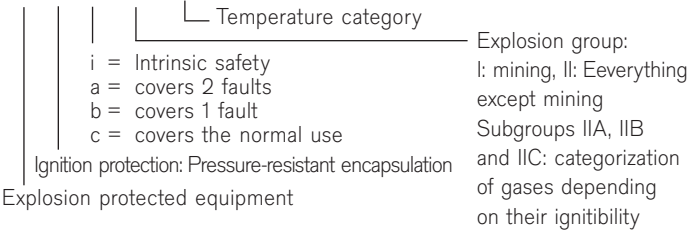

EC type examination certificate:

BVS 10 ATEX E 080X

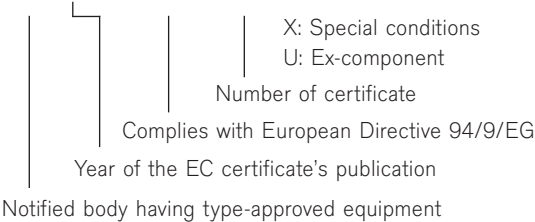

Device categories and safety requirements:

Device group	Category	Safety
I (Mining)	M1	Very high
	M2	High
II (Industry)	1	Very high
	2	High
	3	Normal



Also known as ATEX 137 (formerly ATEX 118a), mandatory in the European Union (EU) since June 30, 2006, addressed to employers and end users concerning the minimum requirements for health and safety for workers in potentially explosive atmospheres.

Zone definition:

Gas, Vapor	Dust	Explosive atmosphere is present...
Zone 0	Zone 20	continuously, long periods or frequently
Zone 1	Zone 21	occasionally, likely to occur
Zone 2	Zone 22	infrequently and for a short time only

Selection of equipment (this table is the link between the categories of ATEX 95 and the zones of ATEX 137):

Operation allowed for	Gas, vapor (G)	Dust (D)
Devices of category 1	in zone 0, 1, 2	in zone 20, 21, 22
Devices of category 2	in zone 1, 2	in zone 21, 22
Devices of category 3	in zone 2	in zone 22

Example: In zone 21 in the industry, where explosive atmospheres caused by dust are likely to occur, the instruments to be used need to have a marking **II 2D** or **II 1D**.

Necessary measures:

- Assessment of the risk of explosion
- Classification of the hazardous area into zones
- Marking of the hazardous places by means of a triangular warning sign “Ex”
- Adequate safety measures
- Explosion protection documentation
- Competence of employees
- Criteria for a permit-to-work system for dangerous work areas

Guideline for risk reduction:

- Prevent the formation of explosive atmospheres, or, if this is not possible:
- Avoid the ignition of the explosive atmosphere, or, if this is not possible:
- Minimize harmful effects of explosions to a tolerable degree.

Requirements for Gas Detection Instruments

Since gas detection instruments and systems are products of safety technology for industrial applications, they need to comply not only with statutory requirements (e.g. explosion protection, electromagnetic compatibility) but also with further requirements, guaranteeing the product quality and reliability of gas detection, even in harsh ambient conditions.

Explosion protection standards:





Design requirements ensure that gas detection devices do not act as a source of ignition. Internationally accepted standards are IEC, EN (ATEX), CSA, UL, GOST, etc.

Protection types in accordance with EN 60529 (IP code)

The IP code provides information concerning the protective properties of the housing against foreign bodies and water.

IP = ingress protection

Excerpt in accordance with DIN EN 60529:

First index number	Protection against solid foreign objects	Second index number	Protection against water
	5 Protection against contact. Protection against interior dust deposits		5 Protection against projected water from any angle
	6 Complete protection against touch. Protection against dust penetration		6 Protection against penetrating water during temporary flooding
			7 Protection against penetrating water during temporary immersion

D-16/08-2009

Protection class IP 67 guarantees a high degree of robustness. This can, however, also have negative consequences when it comes to vapor permeability. For this reason, the MEWAGG (working committee for detection and warning devices for hazardous gases) within BG Chemie (German institution for statutory accident insurance and prevention in the chemical industry) recommends users, who do not simply want to detect gases such as methane and propane, but also higher hydrocarbons or solvents, to have the manufacturer confirm the suitability of the device. This can, for example, be the measurement certificate in accordance with ATEX.

Quality of measurement functions

Compliance with predefined measurement quality, even under extreme ambient conditions (temperature, pressure, wind, humidity, vibration, etc.)

EN 45 544 – for toxic gases and vapors

EN 50 104 – for oxygen

EN 60 079-29-1 – for flammable gases and vapors

Electromagnetic compatibility in accordance with EN 50270

Electrical or electronic devices should not be affected or disrupted by electrical, magnetic or electromagnetic fields. For example, the use of a mobile phone or 2-way radio close to a gas detection instrument must not disrupt the instrument's measurement signal, and vice versa. Electromagnetic compatibility directives and standards provide evidence and confirmation of immunity to interference and low transient emissions.



The calibration of gas detection instruments is extremely important. Obviously gas detection instruments cannot measure correctly if they are incorrectly calibrated.

Dräger-Tubes and CMS

These two detection instruments are delivered calibrated. Until the actual measurement, or until the expiration date, the hermetically sealed glass tube ensures that the calibration remains stable, providing that the storage conditions printed on the label are adhered to.

Sensors / portable gas detection instruments

Sensors are used for continuous measurements. Environmental influences or other gases can change the calibration with which the sensor is delivered to the customer. BG Chemie therefore recommends regular checks / calibrations in its data sheets T021 (gas warning equipment for toxic gases/vapors) / T023 (gas warning equipment for explosion protection). For the members of the European Union, the relevant standard is EN 60079-29-2 or for international use IEC 60079-29-2.

While zero calibration is rather simple because the ambient air can be used in most cases for this purpose, calibration of the sensitivity (or span calibration) is not so trivial.

Electrochemical sensors must be calibrated with reactive gases for the same reason why they can detect these gases. Unfortunately a lot of reactive gases also react in low concentrations with (moist) material surfaces and plastics. For this reason, it is important to keep the passages between test gas and device as short as possible. Therefore, manufacturers of gas detection instruments provide calibration accessories that meet these requirements and are optimized for their gas detection devices.

If, for safety reasons, the so-called target gas (the gas to be detected during operation) is always to be used for calibration, there are also many reasons to use an alternate test gas for calibration.

If a variety of gases are to be detected by just one sensor, the sensor must be calibrated for the gas to which the sensor is the least sensitive. The gas detector is then calibrated in the safest way, because all other gas concentrations are regarded as too sensitive.

Test gases are provided as single gases and also gas mixtures for calibrating multi-gas detectors.

The risk to humans through a variety of hazardous substances at the workplace and in the environment is increasing inexorably in our technology-oriented society.

Rapid, comprehensive information that can be accessed at any time plays a crucial role in implementing the correct measures.

The extensive database Dräger VOICE provides you with up-to-date information on more than 1 700 hazardous substances and 11 500 synonyms.

Dräger VOICE is characterized in particular by the clear links between hazardous substances, measurement options and protective equipment. Information on the proper handling of the recommended products provides additional safety while using.

A wide range of constantly updated **substance information** is available for every selected substance:

- Current national and international limit values
- Chemical/physical information (formulas, vapor pressure, melting and boiling points, etc.)
- Fire protection information (LEL, UEL, flashpoint, ignition point, etc.)
- Identifiers (CAS No., UN No., EC No.)

The Dräger VOICE hazardous substance database is available online at www.draeger.com/voice.

D-27830-2009

Dräger VOICE: Hazardous Substance Database



Properties of Dangerous Gases and Vapors

Flammable and toxic gases and vapors may occur in many places. Dealing with this risk and the danger of explosion – this is what Dräger's gas detection systems are for.

This brochure is meant to give a basic introduction to gas detection technology, measuring principles and safety concerns.

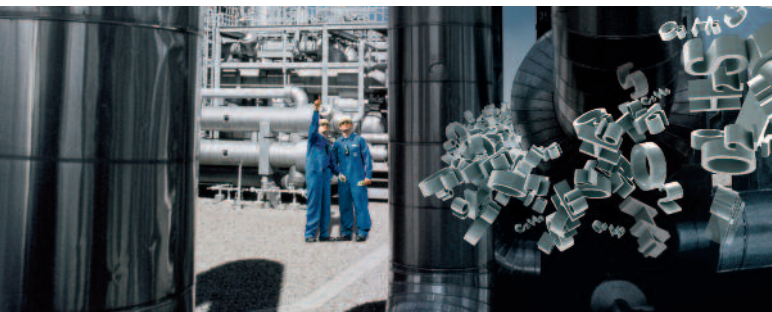

Measurement Principles

Dräger offers a number of instruments with a diverse range of measurement principles for detecting gases and vapors:

- Dräger-Tubes
- Dräger Chip Measurement System
- Electrochemical Sensors
- Catalytic Bead Sensors
- Infrared Sensors
- Photoionization Detectors (PID)



Usage and Requirements of Gas Detection Instruments

Portable gas detection instruments must be able to reliably detect a wide range of hazardous substances under changing conditions. This places great demands on reliability, robustness and flexibility, as the detection instruments are ultimately directly responsible for the health and safety of employees. Not every device can be used in every working atmosphere. Before using a device, ensure that the device specifications are sufficient. These requirements are defined in several standards and directives.

HEADQUARTERS

Draeger Safety AG & Co. KGaA
Revalstrasse 1
23560 Lübeck, Germany

www.draeger.com

SUBSIDIARIES

AUSTRALIA

Draeger Safety Pacific Pty. Ltd.
Axxess Corporate Park
Unit 99, 45 Gilby Road
Mt. Waverley Vic 3149
Tel +61 3 92 65 50 00
Fax +61 3 92 65 50 95

CANADA

Draeger Safety Canada Ltd.
7555 Danbro Crescent
Mississauga, Ontario L5N 6P9
Tel +1 905 821 8988
Fax +1 905 821 2565

P. R. CHINA

Beijing Fortune Draeger Safety
Equipment Co., Ltd.
A22 Yu An Rd, B Area,
Tianzhu Airport Industrial Zone,
Shunyi District, Beijing 101300
Tel +86 10 80 49 80 00
Fax +86 10 80 49 80 05

FRANCE

Draeger Safety France SAS
3c route de la Fédération,
BP 80141
67025 Strasbourg Cedex 3
Tel +33 3 88 40 59 29
Fax +33 3 88 40 76 67

ITALY

Draeger Safety Italia S.p.A
Via Longarone 35
20080 Zibido San Giacomo (MI), Italy
Tel +39 02 90 59 49 1
Fax +39 02 90 00 36 86

MEXICO

Draeger Safety S.A. de C.V.
Av. Peñuelas No. 5, Bodega No. 37
Fraccionamiento Industrial
San Pedrito
Querétaro, Qro México
Tel +52 442 246-1113
Fax +52 442 246-1114

NETHERLANDS

Draeger Safety Nederland B.V.
Edisonstraat 53
2700 AH Zoetermeer
Tel +31 79 344 46 66
Fax +31 79 344 47 90

REP. OF SOUTH AFRICA

Draeger South Africa (Pty) Ltd.
P.O.Box 68601
Bryanston 2021
Tel +27 11 465 99 59
Fax +27 11 465 69 53

SINGAPORE

Draeger Safety Asia Pte Ltd
67 Ayer Rajah Crescent #06-03
Singapore 139950
Tel +65 68 72 92 88
Fax +65 65 12 19 08

SPAIN

Draeger Safety Hispania S.A.
Calle Xaudaró 5
28034 Madrid
Tel +34 91 728 34 00
Fax +34 91 729 48 99

UNITED KINGDOM

Draeger Safety UK Ltd.
Blyth Riverside Business Park
Blyth, Northumberland NE24 4RG
Tel +44 1670 352-891
Fax +44 1670 356-266

USA

Draeger Safety, Inc.
101 Technology Drive
Pittsburgh, PA 15275
Tel +1 412 787 8383
Fax +1 412 787 2207